





-  **FORCHE PER MOVIMENTAZIONE LETAME E MATERIALI DIVERSI**
 **FORKS FOR MANURE'S AND DIFFERENT MATERIALS' HANDLING**
 **FOURCHES POUR LA MANIPULATION DU FUMIER ET DES MATÉRIAUX DIFFÉRENTS**
 **GABELN FÜR MIST - UND VERSCHIEDENEN MATERIALUMSCHLAG**

	PESO ESCAVATORE 2t - 9t R 69-70-71-74FL EXCAVATOR WEIGHT POIDS DE LA PELLE BAGGER GEWICHTSKLASSE 9t - 25t R 175-176
---	--

	PORTATA GRU A BRACCIO SFILATO CRANE CAPACITY AT THE BOOM END CAPACITÉ GRUE À ALLONGEMENT MAXI TRAGKRAFT ENDE KRANAUSLEGER 0.3t - 2.5t R 69-70-71-74FL
---	--

MODELLO • MODEL MODÈLE • MODELL		R 69	R 70	R 71	R 74FL	R 175	R 176
PESO • WEIGHT POIDS • GEWICHT	Kg	70	150	190	280	440	1050
PRESS. • PRESS. PRESS. • DRUCK	Bar	260	260	260	280	280	280
DENTI N° • TEETH NO. DENTS N. • ZÄHNE STK.	N.	8	10	14	10	16	22
DIMENSIONI SIZES DIMENSIONS ABMESSUNGEN	A	900	1040	1040	1390	1640	2210
	C	790	950	950	1080	1100	1430
	D	965	1140	1140	960	960	1290
	E	900	1090	1090	570	760	980
	L	450	600	930	1000	1080	1100



R 69 - R 70 - R 71

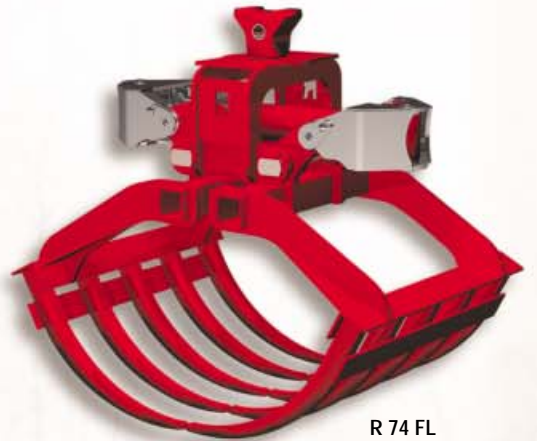

R 74 FL

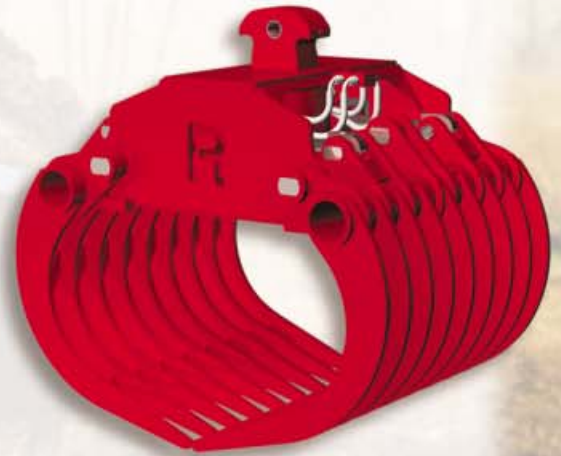

R 175 - R 176

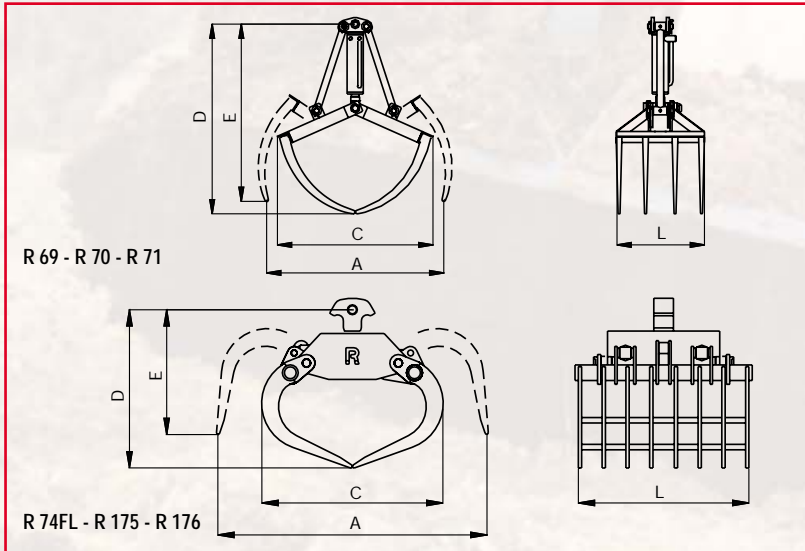

Rozzi

S.p.A.



AKSEM Makina Maden Müh. San. ve Tic. Ltd. Sti.
 Sirasogutler, Çelikoglu Cad. No:145, Çayırova-Gebze
 Tel.: 0.262.655 02 65
 Faks: 0.262.655 02 33
 www.aksemmakina.com e.posta: info@aksemmakina.com